

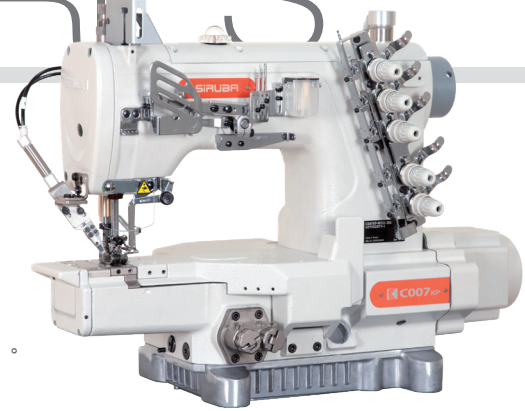

# C007KP SERIES FEATURES



## 內縮式床台

縫製物更靠近針孔，車縫定位精準，車縫時更加順暢就手。

### The Recessed Machine Bed

With the recessed machine bed, sewing material comes closer to the needle hole, thus provides more precise easier, and smoother sewing.



## 新設計上下切刀組

新設計氣、電動上下切刀組，出刀穩定精確，切線俐落，調整容易。

### New-Designed Top and Under Trimmer

The new-designed pneumatic, electric top & under knife combination have fast, stable and precise. Trims thread neatly. Handy operation, easy to adjust.

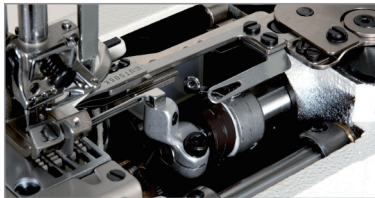

## 針棒與勾針的新油封結構

新的油封設計強化了機構的油附著力，減少了潤滑油甩出。同時使用高耐磨材料，顯著提高性能及耐久性。

### New Oil Sealing Technology

New oil sealing structure used on needle bar and looper mechanism can efficiently avoid oil splash. New wear-resistant material also enhances performance and durability.



## 短筒座的設計

操作性能優越，可因應廣泛的飾蓋縫紉工程，增加延伸蓋就可以車縫包邊或包帶之縫紉工程。

### Recessed Cylinder Bed

The recessed cylinder bed on the front cover is shortened. The short cylinder has superior operating performance, which can be applied to the extensive covering seam. Hemming or wrapping can be sewed just by increasing the extended cover.

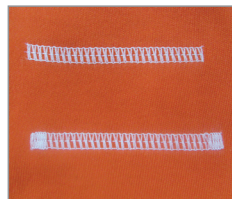

## 密縫裝置

藉由縮短送具行程，在車縫起始或結束進行密縫的功能，確保縫線不易脫落，提高車縫品質，基本車為腳踏板控制，電動和氣動控制為選配。

### Condense Stitching Device

By reducing the strokes of feed dog, at the beginning and the end of sewing, condense stitching reinforces the stitches. This enhances the sewing sturdiness and quality. Basic model is controlled by pedal. Electric and pneumatic controls are optional.



## 新設計上夾線裝置

出刀迅速精準，夾線穩定。

### Brand New Design Upper Thread Gripper

The newly designed upper thread gripper provides fast, precise movement and stable thread gripper.

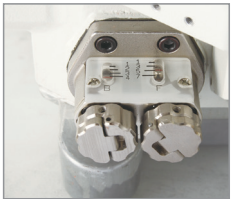

### 送具並列式調整鈕設計

[專利] 前送齒及後送齒，藉由全新並列式調整鈕設計，可獨自調整同步或正逆差動，指標刻度方便使用者進行精確調整前後送齒，大大提升操作者使用上的便利性。

### Front and Rear Feed Dog Minute Adjustment

[Patent] Synchronization or forward / reverse differential of front and rear feed dog can be finely adjusted alone by the brand new parallel adjustable feed dog control knobs. Furthermore, the indicator scales is easy for user to adjust the feeding precisely, which improves ease of operation greatly.

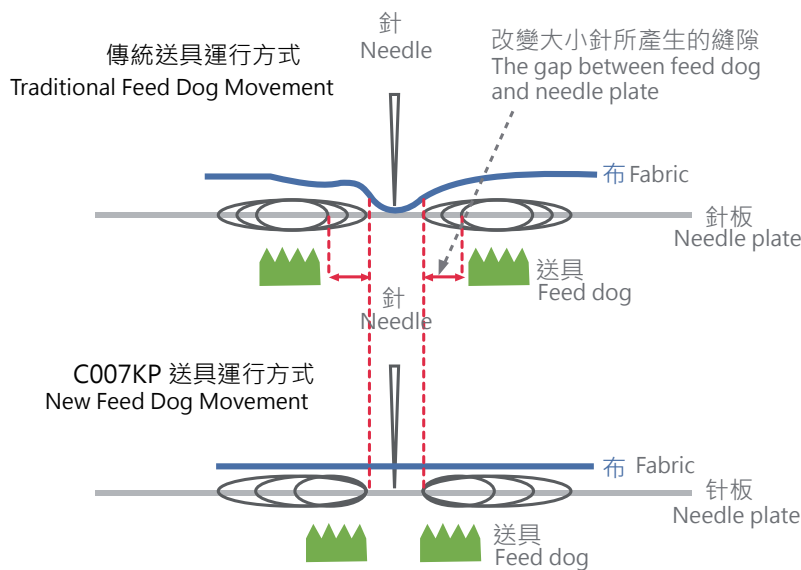

### 全新移動送齒之傳動設計

[專利] 後、前送齒依據橢圓式運動方式，統一由針孔向外運動延伸，縫製物可獲得精準穩定送布，也不會因為過骨或差動而前、後送具產生間隙，影響車縫品質。

### Brand New Differential Feed Dog Driving Design

[Patent] The front and rear feed dog move elliptically, and centrally, a direct extension from needle hole, thus enable sewing material to get precise and stable feeding. Therefore, the sewing quality will not be affected by the clearance between front and rear feed dog which is resulted from the cross seam or differential action.

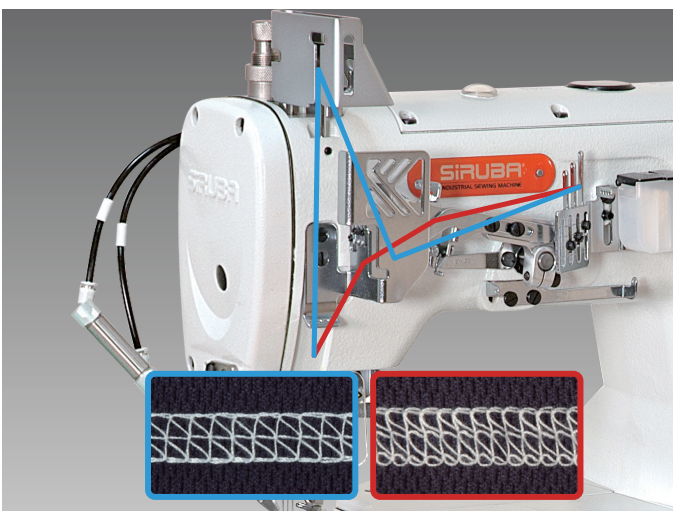

### 雙天秤挑線控線組

全新雙天秤挑線控線組的設計，縫製厚、薄布料皆適用，車縫適用範圍更廣，適用性更高。

### Dual Thread Take-up Mechanism

The brand new design of dual thread take-up lever thread tension combination is ideal for both heavy and light fabric. Sewing applicable range is wider and the applicability is higher.

- 中厚布料 (Medium heavy fabric)
- 薄布料 (Light fabric)



## 規格

## SPECIFICATIONS

## C007KP - W122 - 2 40 /CH/DCKU

規格索引，詳細請參考P.65 Specification index, please refer to P.65

- ① 機種別 Model
- ② 系列 Series
- ③ 網線方式 Covering Types
- ④ 功能 Function
- ⑤ 針板舌片 Needle Plate Finger
- ⑥ 針數 Needle Numbers
- ⑦ 針距 Needle gauge
- ⑧ 配件 Device
- ⑨ 馬達 Motor  
U : U Series  
H : H Series

### C1

	⑥	④	⑤	⑦	⑧	⑨	⑨	
C007KP-W122-⑥⑦/CH/(⑨)	2	4	3.2/ 4.0/ 4.8	1.4 ~ 3.6	0.3 ~ 2.9	5/7	H / U	6000
	3	5	4.8/ 5.6/ 6.4	1.4 ~ 3.6	0.3 ~ 2.9	5/7	H / U	6000
C007KP-W162-⑥⑦/CH/(⑨)	2	4	4.0/ 4.8	1.4 ~ 3.6	0.3 ~ 2.9	5/7	H / U	6000
	3	5	4.8/ 5.6/ 6.4	1.4 ~ 3.6	0.3 ~ 2.9	5/7	H / U	6000
C007KP-W122-⑥⑦/CH-4M/(⑨)	3	5	5.6/ 6.4	1.4 ~ 3.6	0.3 ~ 2.9	5/7	H / U	6000



C007KP-W122-356/CH/UTP

### 一般平縫 / 下擺車

本機型為雙面飾繡縫筒車之基本機型，可裝配附件進行多種功能車縫例如：內衣褲、運動衫接縫及下擺車縫(附可調式下擺車縫組)。

### GENERAL SEAMING / BOTTOM HEMMING

Basic model of interlock stitch machine with double side cover-stitching. It is available for various sewing by optional devices. Such as plain seaming and bottom hemming for underwears, sportswears, etc... (equipped with adjustable hemming set)

W122 : 薄中厚多功能對應針板

W162 : 高行程

W122 : Light / Medium / Heavy Material Multi-function

W162 : High needle bar stroke

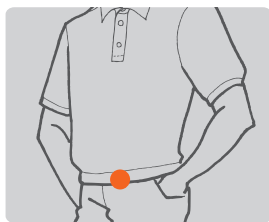

### CH-4M [ 四合一 ]

### 一般平縫 / 下擺車縫 / 拷克倒骨蓋縫 / 上帶滾邊車縫

平縫、折下擺、倒骨、上帶滾邊四合一，更換方便，多樣化功能，高效率、低成本。

### CH-4M [ 4 in 1 ]

### GENERAL SEAMING / BOTTOM HEMMING / COVERING (Fold-down Type) / TAPE BINDING.

4-in-1 model for multifunctional and efficient production with lower cost.

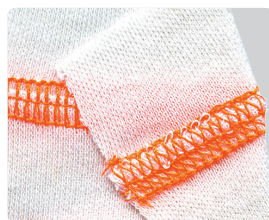

#### 選購配件 OPTIONAL DEVICE

UTP, UTQ, UTR, UTS, CLA, CMR, CAR/UTP, CAR/UTQ

# 規格

# SPECIFICATIONS

## C007KP - W81 2 A - 2 32/ CRL / DCKU

規格索引，詳細請參考P.65 Specification index, please refer to P.65

- ① 機種別 Model
- ② 系列 Series
- ③ 網線方式 Covering Types
- ④ 功能 Function
- ⑤ 針板舌片 Needle Plate Finger
- ⑥ 針數 Needle Numbers
- ⑦ 針距 Needle gauge
- ⑧ 配件 Device
- ⑨ 馬達 Motor  
U : U Series  
H : H Series

### C2

	⑥	⑦	⑧	⑨	⑩	⑪	⑫	⑬
C007KP-W812A-⑥⑦/CRL/(⑨)	2	4	3.2/ 4.0/ 4.8	1.4 ~ 3.6	0.3 ~ 2.9	5/7	H / U	4500
	3	5	5.6/ 6.4	1.4 ~ 3.6	0.3 ~ 2.9	5	H / U	4500

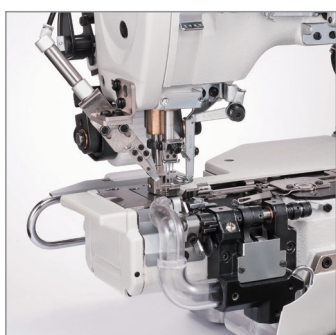

C007KP-W812-356/  
CRL

### 左切刀下擺車縫

附左切刀修齊布邊後，再進行下擺車縫工程，適用於車縫T恤、汗衫之下擺等。

### BOTTOM HEMMING WITH LEFT SIDE FABRIC TRIMMER

Left hand side fabric trimming before hemming. For sleeve opening and bottom of underwears, T-shirt, or sportswears, etc...



適用規格 APPLICABLE SPEC.
W812, U812

\* 薄布料建議選購 W 8 1 1  
Recommended for thin fabrics

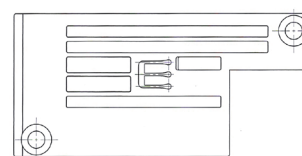

選購配件 OPTIONAL DEVICE
UTP, UTQ, UTR, CL, CMR, CAR/UTP, CAR/UTQ

### C3

	⑥	⑦	⑧	⑨	⑩	⑪	⑫	⑬
C007KP-W222-⑥⑦/CQ/(⑨)	2	4	4.0/ 4.8	1.4 ~ 3.6	0.3 ~ 2.9	5/7	H / U	6000
	3	5	5.6/ 6.4	1.4 ~ 3.6	0.3 ~ 2.9	5/7	H / U	6000
C007KP-W222-⑥⑦/CQA/(⑨)	3	5	5.6	1.4 ~ 3.6	0.3 ~ 2.9	5/7	H / U	5000



C007KP-W222-356/CQ

### CQ:上帶滾邊車縫

適用於內衣褲、T恤之領口、褲管口等上帶滾邊之車縫工程。  
註：滾邊器尺寸為入布端寬1-3/8"，出布時折成三折，出口端成品寬為1/2"。

### CQ:TAPE BINDING

For tape binding on openings of leg or neck of underwears, T-shirts, etc...  
Remark : Binder's opening size is 1-3/8" wide and finished size is 1/2" wide in three folds.

選購配件 OPTIONAL DEVICE
CLA, FA





① ② ③ ④ ⑤ ⑥ ⑦ ⑧ ⑨

## 規格

## SPECIFICATIONS

## C007KP - W322 - 3 56 /CC/DCKU

規格索引，詳細請參考P.65 Specification index, please refer to P.65

- ① 機種別 Model      ④ 功能 Function      ⑦ 針距 Needle gauge      ⑨ 馬達 Motor  
 ② 系列 Series      ⑤ 針板舌片 Needle Plate Finger      ⑧ 配件 Device      U : U Series  
 ③ 網線方式 Covering Types      ⑥ 針數 Needle Numbers      H : H Series

## C4



C007KP-W322-3⑦/CC/(⑨)	3	5	5.6/6.4	1.4 ~ 3.6	0.3 ~ 2.9	5	H/U	6000
C007KP-W322A-3⑦/CC/(⑨)	3	5	5.6/6.4	1.4 ~ 3.6	0.3 ~ 2.9	5	H/U	6000
C007KP-W322-3⑦/CE/(⑨)	3	5	5.6/6.4	1.4 ~ 3.6	0.3 ~ 2.9	5	H/U	6000

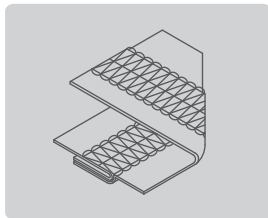

CC

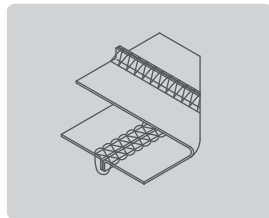

CE

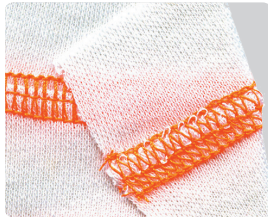

CC

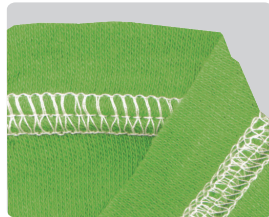

CE

## 拷克倒骨蓋縫

CC 倒骨型：適用於4線包縫之蓋縫。

W322A為兩用型，針板與送具改用W122規格，並附CH組。

CE 立骨型：適用於3線包縫之蓋縫。

配件盒另附有CC倒骨規格之牛角(導布片)。

## OVERLOCK-SEAM COVERING STITCH

CC Fold-down type : For 4-thread overlock-seam covering stitch

W322A is dual-purpose specification, which is with W122's needle plate, feed dog and CH set.

CE Flattening type : For 3-thread overlock-seam covering stitch,

and an extra guide of overlock-seam (CC specification, fold-down type) is included in the accessory box.

選購配件 OPTIONAL DEVICE

UTP, UTQ, UTR, UTS, CLA, CMR, CAR/UTP, CAR/UTQ

## C5



C007KP-W922-4⑦/CW/(⑨)	4	6	5.6/6.0/6.4	1.4 ~ 3.6	0.3 ~ 2.9	5	H/U	6000
-----------------------	---	---	-------------	-----------	-----------	---	-----	------



CW

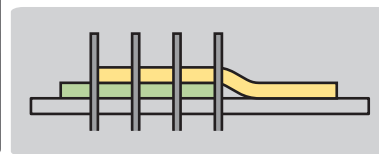

## 四針六線搭接縫

適用於一般內衣褲二片布接縫處之接縫和補強，附有專屬之導邊器，可使二片布順暢縫合。

## FOUR-NEEDLE FLAT SEAMING

For flat seaming 2 pieces of fabric. Equipped with fabric guide for easy operation.

選購配件 OPTIONAL DEVICE

UTQ, UTS, CL, CMR, CAR/UTQ

# 規格

# SPECIFICATIONS

# ① ② ③ ④ ⑤ ⑥ ⑦ ⑧ C007KP - W522 - 2 40 /CR /FE

規格索引，詳細請參考P.65 Specification index, please refer to P.65

- ① 機種別 Model                      ④ 功能 Function                      ⑦ 針距 Needle gauge
- ② 系列 Series                        ⑤ 針板舌片 Needle Plate Finger    ⑧ 配件 Device
- ③ 網線方式 Covering Types       ⑥ 針數 Needle Numbers

## C6

	⑥	④	③	⑦	⑤	②	⑧
C007KP-W522-⑥⑦/CR/FE	2	4	3.2/ 4.0/ 4.8	1.4 ~ 3.6	0.3 ~ 2.9	5	4500
	3	5	4.8/ 5.6/ 6.4	1.4 ~ 3.6	0.3 ~ 2.9	5	4500
C007KP-W522-⑥⑦/CR/FFC	2	4	3.2/ 4.0/ 4.8	1.4 ~ 3.6	0.3 ~ 2.9	5	4500
	3	5	4.8/ 5.6/ 6.4	1.4 ~ 3.6	0.3 ~ 2.9	5	4500
C007KP-W522-⑥⑦/CR/SMK	2	4	3.2/ 4.0/ 4.8	1.4 ~ 3.6	0.3 ~ 2.9	5	4500
	3	5	4.8/ 5.6/ 6.4	1.4 ~ 3.6	0.3 ~ 2.9	5	4500
C007KP-W522-⑥⑦/CR/STC	2	4	3.2/ 4.0/ 4.8	1.4 ~ 3.6	0.3 ~ 2.9	5	4500
	3	5	4.8/ 5.6/ 6.4	1.4 ~ 3.6	0.3 ~ 2.9	5	4500



C007KP-W522-356/CR/FE



C007KP-W522-356/CR/FFC

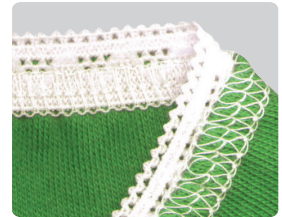
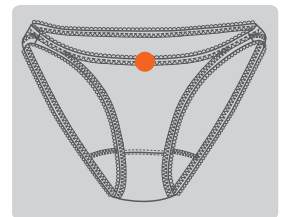
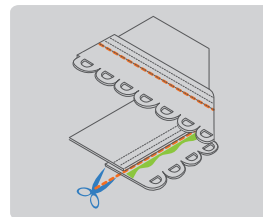

### 鬆緊帶 / 蕾絲鬆緊帶上帶車縫附右切刀

經由上送帶裝置，控制長度與張力，附右切刀修布裝置，能於車縫前將布修齊，更能提高車縫品質，如女用內衣褲之鬆緊帶或蕾絲鬆緊帶車縫。

- FFC:** 機械式送帶
- FE:** 簡易電子式送帶
- SMK:** 電子計數式送帶
  - SMK1-C-01 附定位器，適合簡易伺服或離合器馬達
  - SMK1-C-02 以中繼線，連接伺服馬達
- STC:** 張力控制式送帶
  - STC1-U-01 附定位器，適合簡易伺服或離合器馬達
  - STC1-U-02 以中繼線，連接伺服馬達

選購配件 OPTIONAL DEVICE
CL, LF-A, LS-A, CSA, CSB

### ELASTIC / LACE ATTACHING WITH RIGHT SIDE FABRIC TRIMMER

Top feeding devices ensure even length and tension controlled by electric digital controller, with right side fabric trimmer for elastic or lace attaching smoothly and properly on women's underwears.

- FFC:** Mechanic type tape feeding.
- FE:** Simple electric type tape feeding.
- SMK:** Electric metering type tape feeding
  - SMK1-C-01 with synchronizer for simple servo motor or clutch motor
  - SMK1-C-02 Connected to servo motor by encoder cable.
- STC:** Tension sensor type tape feeding
  - STC1-U-01 with synchronizer for simple servo motor or clutch motor
  - STC1-U-02 Connected to servo motor by encoder cable.



# 規格 SPECIFICATIONS

# C007KP-W532-240/CR/CX/UTP/RLP/DCKU

規格索引，詳細請參考P65 Specification index, please refer to P65

- ① 機種別 Model
- ② 系列 Series
- ③ 網線方式 Covering Types
- ④ 功能 Function
- ⑤ 針板舌片 Needle Plate Finger
- ⑥ 針數 Needle Numbers
- ⑦ 針距 Needle gauge
- ⑧ 配件 Device
- ⑨ 馬達 Motor  
U : U Series  
H : H Series  
\*UTP 請參考 Please refer to P.113

## C7

	⑥	⑦	⑧	⑨	S.P.M. (Max)			
C007KP-W532-⑥⑦/CR/CX/UTP/RLP1/(⑨) *1	2	4	3.2/ 4.0/ 4.8	1.4 ~ 3.6	0.3 ~ 2.9	5	H / U	4500
	3	5	4.8/ 5.6/ 6.4	1.4 ~ 3.6	0.3 ~ 2.9	5	H / U	4500
C007KP-W532-⑥⑦/CR/CX/UTR/RLP1/(⑨) *2	2	4	3.2/ 4.0/ 4.8	1.4 ~ 3.6	0.3 ~ 2.9	5	H / U	4500
	3	5	4.8/ 5.6/ 6.4	1.4 ~ 3.6	0.3 ~ 2.9	5	H / U	4500

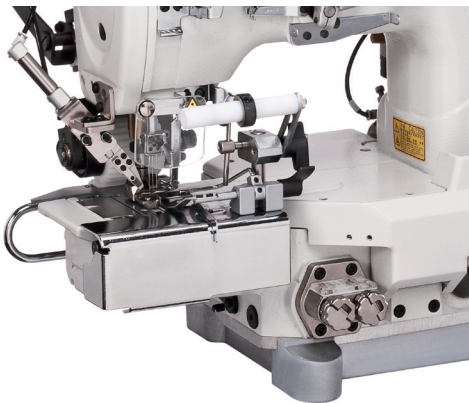

### 環型鬆緊帶褲頭接縫附右切刀

將環型平織鬆緊帶與衣物接縫適用於男女內褲褲腰之鬆緊帶縫合，配合右切刀修布裝置，更能提高縫製品質。

- \*1: 氣動切線，含氣動式吸屑組
- \*2: 電動切線，需另外搭配吸風馬達 (CSA或CSB)

### TUBULAR JACQUARD ELASTIC WAISTBAND ATTACHING WITH RIGHT SIDE FABRIC TRIMMER

For tubular elastic or lace waistband attaching on men's or women's brief, with right hand side fabric trimmer to increase sewing quality and efficiency.

C007KP-W532-356/CR/CX/CL/UTP

- \*1: Pneumatic thread trimmer, including fabric waste suction set
- \*2: Electric thread trimmer, an optional suction motor (CSA or CSB) is required.

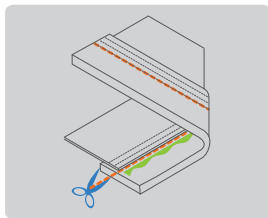
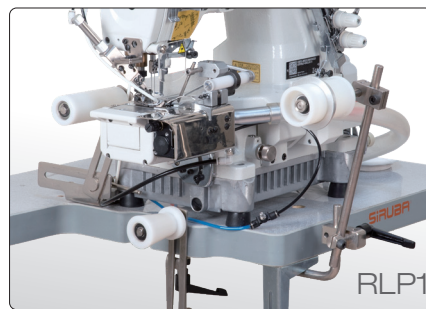
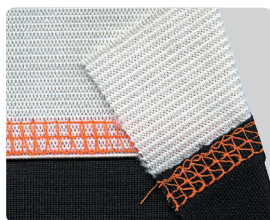
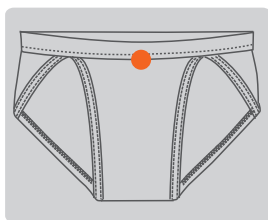

選購配件 OPTIONAL DEVICE
CL* , CAR/UTQ , CMR , CSA , CSB

\*建議採用CL後拉輪，以提高車縫穩定性。  
\*CL rear puller is recommended to improve sewing stability.



規格 SPECIFICATIONS C007KP- W822- 2 40/CRL/CHP/UTP/DCKU

規格索引，詳細請參考P.65 Specification index, please refer to P.65

- ① 機種別 Model
  - ② 系列 Series
  - ③ 網線方式 Covering Types
  - ④ 功能 Function
  - ⑤ 針板舌片 Needle Plate Finger
  - ⑥ 針數 Needle Numbers
  - ⑦ 針距 Needle gauge
  - ⑧ 配件 Device
  - ⑨ 馬達 Motor  
U : U Series  
H : H Series
- \*UTP 請參考 Please refer to P.113

C8

	⑥	⑦	⑧	⑨	S.P.M. (Max)			
C007KP-W822-⑥⑦/CRL/CHP(CY)/UTP/(⑨)	2	4	3.2/ 4.0/ 4.8	1.4 ~ 3.6	0.3 ~ 2.9	5	H / U	4500
	3	5	5.6/ 6.4	1.4 ~ 3.6	0.3 ~ 2.9	5	H / U	4500



C007KP-W822-356/CRL/CL/CHP/UTP

**[二合一]氣動式下擺車縫 / 環型鬆緊帶折縫  
附左切刀**

氣動式布料導邊器能將布料及鬆緊帶順暢的捲折，此外左切刀切齊後再進行縫紉，可增加包縫工程之品質與效率，適用於男內褲、運動褲等褲頭鬆緊帶包縫。

**[2 IN 1]  
PNEUMATIC HEMMING / TUBULAR ELASTIC TAPE HEMMING WITH LEFT SIDE FABRIC TRIMMER**

With pneumatic driving folder to fold fabric and insert elastic smoothly, left hand side fabric trimming before hemming increases sewing quality & efficiency. For hemming sleeve opening and bottom of underwears, T-shirts, or sportswears, etc...

CHP

CY



CHP (CRL 163)  
氣動式下擺車縫  
Pneumatic Hemming



CY (CRL178-A)  
氣動式環型鬆緊帶折縫  
Pneumatic Tubular Elastic Tape Hemming

適用規格 APPLICABLE SPEC
W821, W822, W823, U821, U822, U823
選購配件 OPTIONAL DEVICE
CL*, RL, UTQ, CMR, CAR/UTQ

\*建議採用CL後拉輪，以提高車縫穩定性。  
\*CL rear puller is recommended to improve sewing stability.





# 規格

# SPECIFICATIONS

# C007KP - W152 - 3 56/ CZ/ RLQ/ DCKU

規格索引，詳細請參考P.65 Specification index, please refer to P.65

- ① 機種別 Model                      ④ 功能 Function                      ⑦ 針距 Needle gauge                      ⑨ 馬達 Motor
- ② 系列 Series                          ⑤ 針板舌片 Needle Plate Finger      ⑧ 配件 Device                              U : U Series
- ③ 網線方式 Covering Types      ⑥ 針數 Needle Numbers                      H : H Series

## C9

	⑥	⑦	⑧	⑨	⑩	⑪	⑫	⑬
C007KP-W152-3⑦/CZ/RLQ/(⑨)	3	5	5.6/6.4	1.4 ~ 3.6	0.3 ~ 2.9	5	H/U	6000
C007KP-W152-3⑦/CZP/RLQ/(⑨)	3	5	5.6/6.4	1.4 ~ 3.6	0.3 ~ 2.9	5	H/U	6000



C007KP-W152-356/CZ/UTP

### 環型羅紋褲頭鬆緊帶包縫

#### CZ:氣動式 / CZP:膝動式

將環型羅紋鬆緊帶縫入原體，適用於男女內褲、褲腰之羅紋鬆緊帶包縫再配合自動切線裝置及筒型衣物撐開滾輪組，更能提高縫製效率  
註：本機型標準配備二折式導布裝置，可另訂三折式導布裝置。

### TUBULAR ELASTIC WAISTBAND ATTACHING CZ:PNEUMATIC TYPE / CZP: MANUAL TYPE

Attaching tubular elastic tape onto waistband, suitable for briefs. With auto-trimming and tubular extending roller can increase sewing quality and efficiency.

Remark : Two-fold fabric guider is standard, three-fold fabric guider is optional.

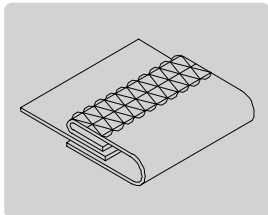
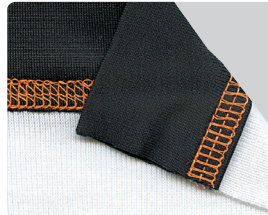
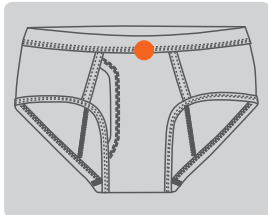

三折 3-Fold  
(CZ01K,CZ03K)

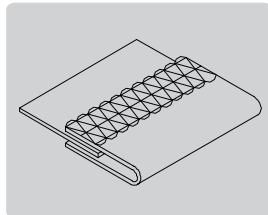

兩折 2-Fold  
(CZ21K,CZ22K)

RLQ

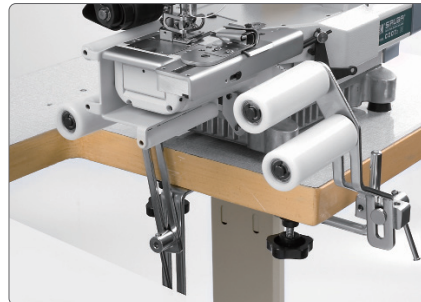

機型 MODEL	選購配件 OPTIONAL DEVICE
CZ	CL* , UTP , UTQ , CMR , CAR/UTP , CAR/UTQ
CZP	CL* , UTP , UTQ , UTR , UTS , CMR , CAR/UTP , CAR/UTQ

\*建議採用CL後拉輪，以提高車縫穩定性。

\*CL rear puller is recommended to improve sewing stability.

# 規格

# SPECIFICATIONS

# C007KP - W542 - 2 40 /CFC

規格索引，詳細請參考P.65 Specification index, please refer to P.65

- ① 機種別 Model
- ② 系列 Series
- ③ 網線方式 Covering Types
- ④ 功能 Function
- ⑤ 針板舌片 Needle Plate Finger
- ⑥ 針數 Needle Numbers
- ⑦ 針距 Needle gauge
- ⑧ 配件 Device
- ⑨ 馬達 Motor  
U : U Series  
H : H Series

## C10

	⑥	針	mm	⑦	mm	mm	S.P.M. (Max)
C007KP-W542-⑥⑦/CFC	2	4	4.0/ 4.8	1.4 ~ 3.6	0.3 ~ 2.9	5/7	3500
	3	5	5.6/ 6.4	1.4 ~ 3.6	0.3 ~ 2.9	5/7	3500
C007KP-W542-⑥⑦/SMK	2	4	4.0/ 4.8	1.4 ~ 3.6	0.3 ~ 2.9	5/7	3500
	3	5	5.6/ 6.4	1.4 ~ 3.6	0.3 ~ 2.9	5/7	3500
C007KP-W542-⑥⑦/STC	2	4	4.0/ 4.8	1.4 ~ 3.6	0.3 ~ 2.9	5/7	3500
	3	5	5.6/ 6.4	1.4 ~ 3.6	0.3 ~ 2.9	5/7	3500

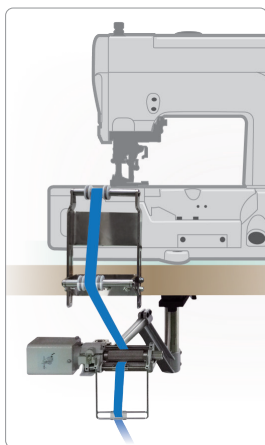

SMK

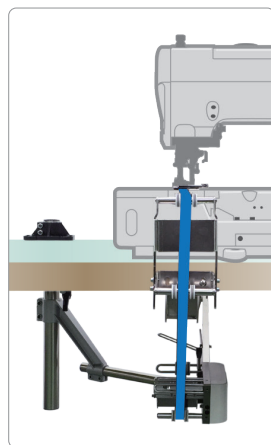

STC

### 鬆緊帶折縫

下送帶配件能有效控制鬆緊帶之鬆緊度，配合三折或二折折布喇叭及鬆緊帶壓縫，可精確進行短褲、內褲等褲腳及褲頭之鬆緊帶折縫。

**CFC:** 機械式送帶

**SMK:** 電子計數式送帶

SMK1-D-01 附定位器，適合簡易伺服或離合器馬達

SMK1-D-02 以中繼線，連接伺服馬達

**STC:** 張力控制式送帶

STC1-B-01 附定位器，適合簡易伺服或離合器馬達

STC1-B-02 以中繼線，連接伺服馬達

### ELASTIC HEMMING

Elastic hemming evenly length and elasticity is controlled by tape feeding device. Great for seam covering with two or three plies hemming binder on elastic for waistband or leg opening of briefs and shorts, etc...

**CFC:** Mechanic type tape feeding

**SMK:** Electric metering type tape feeding

SMK1-D-01 with synchronizer for simple servo motor or clutch motor

SMK1-D-02 Connected to servo motor by encoder cable Tension

**STC:** sensor type tape feeding

STC1-B-01 with synchronizer for simple servo motor or clutch motor

STC1-B-02 Connected to servo motor by encoder cable

可選擇之折布喇叭 Optional Binder			
喇叭型式 Binder Type	機型 Model	喇叭代號 Binder No.	成品尺寸 Finished Size
	2	B523K	9mm
	2A	B523AK	12mm
	3	B524k	9mm
	3A	B524Ak	12mm

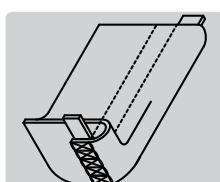
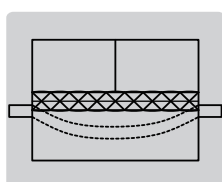
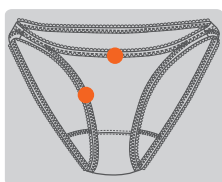

選購配件 OPTIONAL DEVICE

FH, CL\*

\*建議採用CL後拉輪，以提高車縫穩定性。

\*CL rear puller is recommended to improve sewing stability.



# 規格

# SPECIFICATIONS

# C007KP - W122 - 2 40/ FFT/ CH/ DCKU

規格索引，詳細請參考P.65 Specification index, please refer to P.65

- ① 機種別 Model                      ④ 功能 Function                      ⑦ 針距 Needle gauge                      ⑨ 馬達 Motor
- ② 系列 Series                          ⑤ 針板舌片 Needle Plate Finger      ⑧ 配件 Device                              U : U Series
- ③ 網線方式 Covering Types      ⑥ 針數 Needle Numbers                      H : H Series

## C11

	⑥	④	⑦	⑤	③	②	⑧	⑨	①
	針	板	mm	mm	mm	mm	mm	mm	S.P.M. (Max)
C007KP-W122-⑥⑦/FFT/CH/⑨	2	4	4.0/4.8	1.4 ~ 3.6	0.3 ~ 2.9	1~5.5	5	H / U	4500
	3	5	5.6/6.4	1.4 ~ 3.6	0.3 ~ 2.9	1~5.5	5	H / U	4500
C007KP-W131-⑥⑦/FFT/CH/⑨	2	4	4.0/4.8	1.4 ~ 3.6	0.3 ~ 2.9	1~5.5	5	H / U	4500
	3	5	5.6/6.4	1.4 ~ 3.6	0.3 ~ 2.9	1~5.5	5	H / U	4500
C007KP-W132-⑥⑦/FFT/CH/⑨	2	4	4.0/4.8	1.4 ~ 3.6	0.3 ~ 2.9	1~5.5	5	H / U	4500
	3	5	5.6/6.4	1.4 ~ 3.6	0.3 ~ 2.9	1~5.5	5	H / U	4500
C007KP-W812A-⑥⑦/FFT/CRL/⑨	2	4	4.0/4.8	1.4 ~ 3.6	0.3 ~ 2.9	1~5.5	5	H / U	4500
	3	5	5.6/6.4	1.4 ~ 3.6	0.3 ~ 2.9	1~5.5	5	H / U	4500
C007KP-U812A-⑥⑦/FFT/CRL/⑨	2	4	4.0/4.8	1.4 ~ 3.6	0.3 ~ 2.9	1~5.5	5	H / U	4500
	3	5	5.6/6.4	1.4 ~ 3.6	0.3 ~ 2.9	1~5.5	5	H / U	4500
C007KP-W812A-⑥⑦/FFT/CRL/CW/⑨	4	6	5.6/6.0/6.4	1.4 ~ 3.6	0.3 ~ 2.9	1~5.5	5	H / U	4500



### FFT 上送布功能

[ 專利 ] 優化前後移動送具之結構設計，有效送布的行程更大，車縫送布更穩定。

### FFT TOP FEEDING FUNCTION

Back and forth moving feed dog is designed by patent and improved mechanism. The effective feeding stroke is bigger, and fabric feeding is more stable.

選購配件 OPTIONAL DEVICE
UTP, UTR

\* 薄布料建議選購 W811  
Recommended for thin fabrics

